

PROJECT:	SPECIFIER:	TYPE:	QTY:	DATE:
1	2	3	4	5
6	7	8	9	10
11				



TECH OPTIONS



DESCRIPTION

Specification grade downlight with aluminum alloy primary reflector available in wide range of finishes. Open trim with variety of field changeable beam distributions and impressive high output options available up to 9500 lm for tall ceilings. Inherently protected luminaire with IC and non-IC options available. Thermal protection in case of improper insulation use. Extruded aluminum anodized heat sink or electrocoated aluminum bracket only for lower outputs. Positive retention springs allow for easy installation and prevent sagging.

FEATURES

- Housing & Trim:** aluminum, Alzak anodize and paint finish options
- Cutout:** round
- Optic:** open trim with variety of optics available; field changeable
- Beams:** narrow regress optic, medium regress optic, wide regress optic, asymmetric wallwash
- Lumen Output (nominal):** up to 9860+ lm, 110 lm/W
- Mounting:** new construction, remodeler, and IC housing box
- Heat Sink:** extruded anodized aluminum for higher outputs or electrocoated aluminum bracket for lower outputs
- LED:** PerfectWhite™ human centric, Tunable White, Warm Dim, Static white
CRI 90+ & 95+, Sunlike 97, RGBW
≤1x3 SDCM standard, ≤1x2 SDCM available upon request
LED Lumen Maintenance: L70 > 50,000hrs

DIMENSIONS

- Aperture (A):** 7.06" Ø
- Flange (B):** 8.50" Ø
- Height (C):** 6.56" - 8.93"
- Min. Ceiling Opening:** 7.8" Ø
- Ceiling Thickness:** ½" - 2" thk

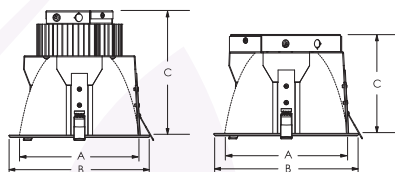

WARRANTY 5 Year Limited Warranty (Covers Standard Components)

RATINGS & CERTS

Made In USA with Global Components
Damp Location Rated, Wet Location Rated



1: TYPE	RB8-RD RB8-RDW	Recessed Downlight Recessed Downlight, Wet Location
2: LED COLOR & CRI	<p>WD97-3018K* Warm Dim 3000-1800K 97+ WD92-4027K* Warm Dim 4000-2700K 92+ LX90-RGBW** Lumenetix RGB + 8000-1650K White 90+</p> <p>PC90-30K 3000K PerfectWhite™ 90+ SW80-27K 2700K Static White 80+ SW80-30K 3000K Static White 80+ SW80-35K 3500K Static White 80+ SW80-40K 4000K Static White 80+ SW80-50K 5000K Static White 80+ SW80-57K 5700K Static White 80+ SW80-65K 6500K Static White 80+ SW90-27K 2700K Static White 90+ SW90-30K 3000K Static White 90+ SW90-35K 3500K Static White 90+</p> <p>SW90-40K 4000K Static White 90+ SW90-50K 5000K Static White 90+ SW95-27K 2700K Static White 95+ SW95-30K 3000K Static White 95+ SW95-35K 3500K Static White 95+ SW95-40K 4000K Static White 95+ SL97-27K 2700K Sunlike 97 SL97-30K 3000K Sunlike 97 SL97-35K 3500K Sunlike 97 SL97-40K 4000K Sunlike 97 SL97-50K 5000K Sunlike 97 TW90-4018K*** Tunable White 4000-1800K 90+ TW90-6527K*** Tunable White 6500-2700K 90+</p>	
3: LUMENS	<p>10LM 1000 lm 15LM 1500 lm 21LM 2100 lm 30LM 3000 lm 43LM* 4300 lm 60LM 6000 lm 70LM 7000 lm 80LM 8000 lm 90LM 9000 lm 100LM 10,000 lm</p>	
4: VOLTAGE	U 120-277Vac 3 347Vac	
5: DIMMING / DRIVER	Leading and trailing edge dimming at 120Vac only	
DIMA1*	1% Universal Dim 0-10V/TRIAC/ELV (4300lm max output)	
AVI	Bluetooth Avi-on BLE Wireless for static white, warm-dim, tunable white & RGBW	
10V	<10% Dim 0-10V	
10V1	1% Dim 0-10V	
10VMC1	1% Dim 0-10V multi-channel for tunable white & Lumenetix full color presets + tunable white	
10VMC21	0.1% Dim 0-10Vx2 dim-to-off for tunable white	
LTEA	1% Dim Lutron Hi-Lume 2-Wire (120V only)	
LUT1	1% Dim Lutron Hi-Lume EcoSystem Soft-on & Fade Black	
LUTZ1**	0.1% Dim Lutron Hi-Lume Premium EcoSystem Soft-On & Fade Black for static white & Lumenetix tunable white	
ELD1	1% Dim eldoLED Ecodrive	
ELDZ1	0.1% Dim eldoLED SOLOdrive dim-to-off	
DMXZ1	0.1% Dim DMX for tunable white & Lumenetix tunable full color and white	
DALIZ1	0.1% Dim DALi2 for tunable white & Lumenetix tunable white	
DALMCZ1	0.1% dim-to-dark DALI2 DT8 dual channel for tunable white	
WATTZ1	0.1% Dim Wattstopper DLM for Lumenetix tunable white	
	* Standard non-linear dim-to-off for 0-10V dimming; for linear dimming add -LIN at end of dim code ** <20W available for static white *** Most drivers use logarithmic dimming curve as standard. For linear curve add "LIN" after Dimming Code	
6: OPTIC	BN 25° TIR BM 35° TIR BW 60° TIR BAWW asymmetric wallwash	
7: REFLECTOR FINISH	AHZ Haze Alzak Clear Anodize PWH White Matte Paint PBK Black Matte Paint ABK Black Anodize AGH Graphite Anodize ABR Bronze Anodize AWE Wheat Anodize	
8: TRIM FINISH	AMI Anti-Microbial Finish MT Match Reflector WH White BK Black	
9: IC RATING (OPTIONAL)	IC Insulated ceiling *Enclosed box required; contact factory for remodeler IC options	
10: ACCESSORY	HBH Ceiling frame with hanger bars & butterfly bracket kit, extendable EN Enclosed box with ceiling plate & bars FMC Flex metal whip, 24-inch for AC power BB4 Battery Backup 4W for 90 mins BB8 Battery Backup 8W for 90 mins GOR Adapter GooF Ring REM Remodel Ring	
11: CONTROL	VIVE Lutron Vive ANL Acuity nLight AIRNL Acuity nLight Air CAS Casambi Ready ENT Enlighted	

LED POWER INFO Insulated ceiling (IC) rating up to 30W / ~3000 lm IC rated

Static White LED 80+ CRI @ 3000K (nominal)

Ordering Code	Lumens, Nominal Delivered	Input Power, Nominal	Efficacy, Nominal
10LM	1,061 lm	9.83W	108 lm/W
15LM	1,486 lm	13.76W	108 lm/W
21LM	2,130 lm	19.32W	110.3 lm/W
30LM	2,982 lm	27.05W	110.3 lm/W
43LM	4,260 lm	38.64W	110.3 lm/W
60LM	5,964 lm	54.09W	110.3 lm/W
70LM	6,815 lm	61.82W	110.3 lm/W
80LM	7,667 lm	69.55W	110.3 lm/W
90LM	8,926 lm	80.97W	110.3 lm/W
100LM	9,861 lm	89.44W	110.3 lm/W

Static White LED 90+ CRI @ 3000K (nominal)

Ordering Code	Lumens, Nominal Delivered	Input Power, Nominal	Efficacy, Nominal
09LM	899 lm	9.83W	91.4 lm/W
13LM	1,258 lm	13.76W	91.4 lm/W
18LM	1,803 lm	19.32W	93.3 lm/W
25LM	2,525 lm	27.05W	93.3 lm/W
36LM	3,607 lm	38.64W	93.3 lm/W
50LM	5,049 lm	54.09W	93.3 lm/W
60LM	6,131 lm	65.68W	93.3 lm/W
70LM	7,033 lm	75.34W	93.3 lm/W
80LM	8,221 lm	88.07W	93.3 lm/W
90LM	8,751 lm	93.75W	93.3 lm/W

PerfectWhite LED 90+ CRI @ 3000K (nominal)

Ordering Code	Lumens, Nominal Delivered	Input Power, Nominal	Efficacy, Nominal
09LM	924 lm	13.50W	68.4 lm/W
13LM	1,347 lm	19.29W	69.8 lm/W
19LM	1,886 lm	27.01W	69.8 lm/W
27LM	2,694 lm	38.58W	69.8 lm/W

Sunlike LED 97 CRI @ 3000K (nominal)

Ordering Code	Lumens, Nominal Delivered	Input Power, Nominal	Efficacy, Nominal
07LM	706 lm	10.06W	70.2 lm/W
10LM	988 lm	14.08W	70.2 lm/W
14LM	1,425 lm	19.89W	71.7 lm/W
20LM	1,995 lm	27.84W	71.7 lm/W
28LM	2,867 lm	40.00W	71.7 lm/W

Warm Dim LED 92+ CRI @ Full Intensity (nominal)

Ordering Code	Lumens, Nominal Delivered	Input Power, Nominal	Efficacy, Nominal
09LM	900 lm	14.36W	62.6 lm/W
12LM	1,263 lm	20.17W	62.6 lm/W
18LM	1,806 lm	28.24W	63.9 lm/W
26LM	2,580 lm	40.34W	63.9 lm/W

Tunable White LED 90+ CRI @ Cool CCT (nominal)

Ordering Code	Lumens, Nominal Delivered	Input Power, Nominal	Efficacy, Nominal
06LM	616 lm	8.55W	72 lm/W
12LM	1,170 lm	17.11W	68.4 lm/W
18LM	1,694 lm	23.53W	72 lm/W
24LM	2,325 lm	32.278W	72 lm/W
30LM	2,893 lm	40.18W	72 lm/W

Lumenix White LED 90+ CRI @ 4000K

Efficacy	Lumens Delivered	Input Power	Efficacy
08LM	840 lm	20.2W	41.5 lm/W
14LM	1360 lm	33.7W	40.3 lm/W
21LM	2080 lm	56.2W	37 lm/W
35LM	3480 lm	67.4W	51.6 lm/W

LM Multiplier 1 LED CRI

SW80: 1.00
SW90: 0.90
SW95: 0.75

LM Multiplier 2 LED Color

2700K: 0.96
3000K: 1.00
3500K: 1.03
4000K: 1.05
5000K: 1.07

LM Multiplier 3 Trim Finish

Clear Haze: 1.00
White Paint: 0.90
Black Paint: 0.70

Calculated Delivered Lumens = Delivered Lumen Value x LED CRI x LED Color x Trim Finish

SPECTRAL POWER DISTRIBUTION

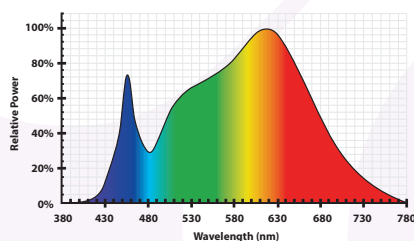

Standard LED 90+ CRI @ 3000K

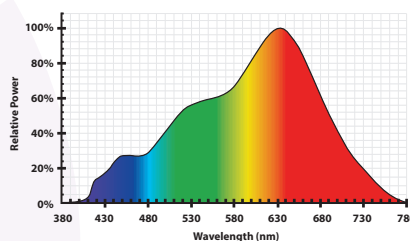

SunLike LED 97 CRI @ 3000K

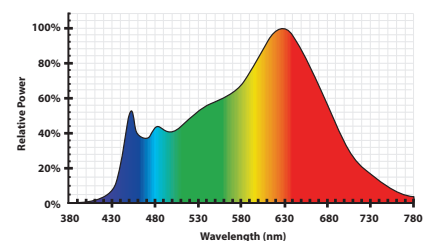

PerfectWhite LED 90+ CRI @ 3000K

09/14/2023
page 2

BEAM DISTRIBUTION

BN - 25° Narrow

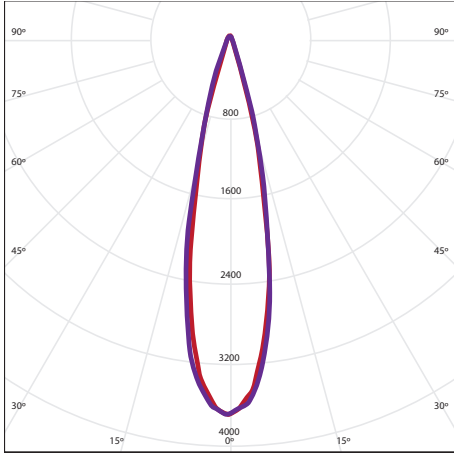

BM - 35° Medium

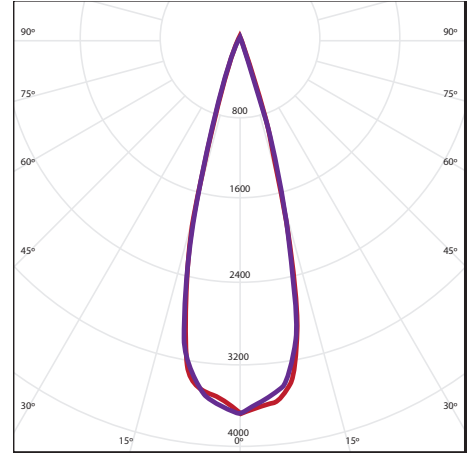

BW - 60° Wide

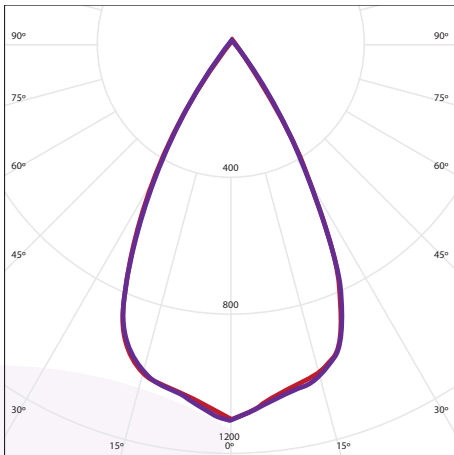

DIMMING

DIMMING COMPATIBILITY FOR -DIMA1 CODE

Opus® Rondo offers compatibility with both phase-cut (reverse-phase and forward-phase) and 0-10V dimmers. Forward-phase (TRIAC) and reverse-phase (ELV) dimming work only at 120Vac. Phase-cut dimming always has priority over 0-10V dimming. Each fixture requires 1mA for 0-10V dimming. Please consult dimmer datasheet for total 0-10V dimming current requirement to determine suitable number of fixtures per dimmer for best dimming results.

COMPATIBLE PHASE-CUT DIMMERS FOR -DIMA1 CODE

120Vac Dimmers					
Mfg.	Model	Mfg.	Model	Mfg.	Model
Lutron	S-603PG	Lutron	DVELV-303P	Lutron	CT-103P
Leviton	IPI06-1LZ	Lutron	SELV-300P	Cooper	SLC03P
Leviton	6631-2	Leviton	6683-IW	Leviton	IPE04
Lutron	DVCL-153P	Leviton	6161	Lutron	MAELV-600
Lutron	DV-600P	Leviton	6633-P	Lutron	FAELV-500
Lutron	TGCL-153P	Lutron	TG-600P	Lightolier	ZP260QEW
Lutron	S-600P	Cooper	DLC03P	Cooper	DAL06P
Leviton	VPE06	Lutron	LG-600P		

COMPATIBLE 0-10V DIMMERS FOR -DIMA1 CODE

0-10V Dimmers		
Mfg.	Model	Part No.
Lutron	Nova series	NFTV
Leviton	IllumaTech series	IP710-DL
Lutron	Diva series	DVTV

0-10V DIM VOLTAGE REFERENCE FOR -DIMA1 CODE

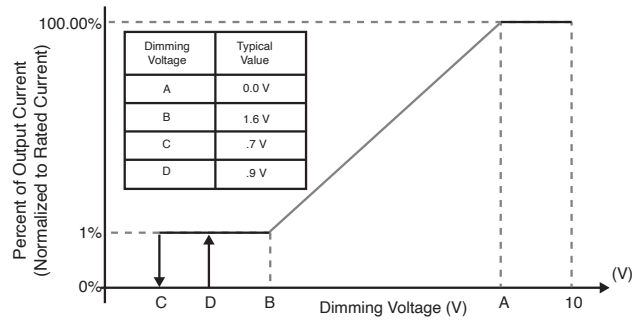

MOUNTING
Remodeler Mounting (No Suffix)

Mounting dimensions shown are for -DIMA1, -10V, -10V1, up to 50W input power and -LUT1, -LUTZ1 up to 20W input power
 Larger remodeler driver box for higher wattages and other dimming options as well, not shown below.

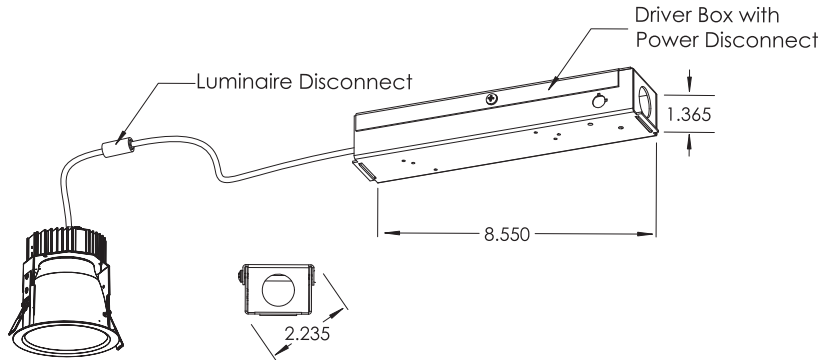
HBH Suffix Mounting
